



1134 N. Oliver Road, Hgr G * Newton, Ks 67114 USA
 Ph. 316-283-7929 Fax 316-283-4702 Email: sales@webcoaircraft.com

ELECTRICAL:

- Light Weight Starter (8 lbs. lighter, cranks faster, no bendix to slick, STC'D)
 No more Hot Starts, 10.2 lbs total weight \$ 775.00
- Battery Cable Kits Using M22759/16-2-9 Per MSB836A 180 & 250 (starter solenoid located top pilot side) \$210.00
- 180 / 250 / 260 (starter solenoid on bottom co-pilot side) \$195.00
- 260B - \$130.00 / 260C - \$192.50 / PA30 - \$245.00 / 400 - \$210.00
- Starter Solenoid 487-149 (602-850)..... \$115.00

REPLACEMENT GASKETS:

- Fuel cell gasket set PA24 (includes all 5 gaskets needed) \$55.00/Tank
- Fuel cell gasket set PA30 (includes all 6 gaskets needed) \$66.00/Tank
- Fuel door gasket W20327-003 \$6.35 PA30 Aux W19051-000 \$6.35
- 462-021 Fuel sender gasket . Call 751-871 Fuel Screen Gasket Call
- 462-014 Large oval cork Call 22846-000 Fuel filler PA30 Aux
- 20366-000 Blk oval (upper thin) 20366-002 Blk oval (lower)

FUEL SYSTEM:

- Fuel Bowl - W22034-00 (180/250/260) \$145.00 Drain valve 22179-00 Call
- Fuel screen combo W22458-000 (PA24 fuel bowl gasket w/screen) .. \$48.50
- Fuel screen strainer PA30 fuel valve P.O.R.
- Fuel sender (transmitter) 20966-000 Main / 20966-002 Aux P.O.R.
- Fuel caps (WEBCO PMA'd) 180/250/260/ PA30 Main or PA30 Aux \$60.00
- Rubber replacements (fuel caps) (Main / Aux / Tip tank) \$19.25
- 12 volt Electric Fuel Boost Pump (Bendix/Facet style Carb. engines) \$678.00
- Fuel Selector wafer switch PA24 (W22843-000) \$195.50
- PA30 Fuel selector decal set \$15.00 PA24 Fuel selector decal set \$13.75
- PA24 or PA30 fuel selector dish (without decal) \$35.75
- Brand New Multi-Ply fuel cells Main & Aux. Call for \$\$\$

GEAR & BRAKE MISC.

- Strut seal kits (PA24 or PA24-400/PA30) (one per gear) . . . \$15.50
- Master Cylinder oring sets \$1.95 to \$7.25
- Bungee Arms W20846-006 Left & W20846-007 Right (Heavy wall) \$325.00
- Bungee Cords (31322-007 or 8097) \$29.50
- Main Gear door hinge W21065-012 \$34.50
- Hub Cap / Wheel cover (round) . . . \$10.20 (raised) . . . \$32.25/\$26.80
- * COMANCHE Bushings and Bolts - Give us a Call... We stock 'em ALL!*

ENGINE & EXHAUST MISC.

- *260 Heated Alternate air induction kit (STC'D) (AD 91-02-06) . . . \$850.00
 - * Turbo Rotary fuel pump metered fuel fitting (AD 91-08-07) . . . \$45.00
 - W16559-000 Carb to airbox coupling boot (accordion style) . . . \$325.50
 - Carb airbox- PA24 Repair Available.....Max \$750.00
 - Airbox Repair Parts/Kits Available.....Call for information
 - Tach Cables (inner core only) PA24 PA30 . . . Call for information
 - Tailpipes 180/Call 250 PMA \$245.00 260 LH or RH Call Tailpipe clamp Call
 - Oil Cooler Hose Kit 180/250/260 .. \$350-\$495 / PA30 (1 Kit / Eng) \$190.00
 - Or send your hoses in for repair.
 - Muffler shroud (PA24) W23489-000 \$489.50
 - Carb Heat Shroud -Lower 180 PMA'....\$104.50 Others avail upon request
 - Baffle rubber kit - 180/250/260/PA30 \$49.50
 - Felt for baffles \$49.50 Rubber AND felt kit \$94.50
 - Vernier Throttle Kit (Black) w/switch.....Call for other engine cable options
 - Prop Governor Cable.....Call for other engine cable options
 - Mixture Control Cable.....Call for engine other cable options
 - (* All 3 above cables require 337 field approval)
 - Vernier Control Cable-112*-FAA-PMA'D.....\$228.50
 - All Control Cables for PA30 (Push/Pull) . . . Call for Price & Availability
- Don't forget to ask about our nacelle auxiliary tanks for PA30/PR39**

DOOR:

- Upper Door latch kit (STC'd - Cherokee style) \$785.00
- Lower hinge area repair kit (brace/reinforcement) Call for Info
- Holder (catch) repair kit (spring & rollers for door holder) \$18.00
- Cabin Door Seal - Regular/(PA24 co-pilot side baggage doors) \$5.95/Ft
- Baggage Dr Seal PA24 Pilot side & all PA30 (23183-000) 10' len \$73.10/44.85
- Plus Inner Cord (for the 23183-000).....187-652 (8' len) \$3.00/Ft
- Door Lock mechanism (Reg) \$16.50 or (Tubular Cam). \$26.85
- Interior handle Piper \$90.00 or *** Call for options

WINDOWS:

- <Clear> <Tint>
- 1/4" STC'd Complete Set - 4 place (less windshield) Call.....Call
- 1/4" STC'd Complete Set - 6 place (less windshield) Call.....Call
- Windshield 1/4" 1 PC (FOB factory) Call.....Call
- Windshield 1/4" 2 PC (FOB factory) (each) Call.....Call
- Caulking/Sealant for windows/windshield (per tube) \$5.00

MISC:

- Make all your orders easy. Complete PARTS or SERVICE manuals
- Parts/Service PA24 Parts/PA30 Parts....\$58.50 PA30/39 Service \$70.00
- Aileron Bulkhead Kit (763-893) \$1923.40
- Hinge Bracket kit (760-914) Call
- PA30 Rudder Tip \$238.90 PA30 Beacon Fairing \$?
- Stabilator tip PA24 or PA30 - Plastic Call Fiberglass \$187.50 / \$160.00
- Tail Cone Fairing (Fiberglass) \$132.00
- Wing root seal Upper set (2 wings) \$92.70 Lower set (2 wings) \$44.50
- Wing tip mirrors (visually check gear down) Call for Info
- Nav Light reflectors (visually check your nav lites) RH or LH Call for Info
- Landing Light Lenses W20348-000 LH & W20348-001 RH (LEXANI) \$43.50
- Trim Seal (J Channel) \$2.25 per foot
- Cowl Chafe Cotton seal strip ...Starting at \$1.00/FT various widths
- Canvas Nose wheel cover PA30 23956-000 Call for Info
- Wheel well liner/cover PA30 or PA24 (LH or RH) Call
- PA30 Nose bowl hinges - Hinge pin upper or lower Call-Repair Parts Available
- Cowl support rod (PA24) Call for info
- Heated Pitot Tube Call for Info Pitot tube mounting mast Call for Info
- Rubber steering rod boot 21378-000 \$50.00
- NEW SKIN STOCK AND BULKHEAD BLANKS
- Flap, Aileron, Rudder, Stabilator, Fuselage and Wings. Most Available.

CALL.

ACCESSORY REPAIR/EXCHANGE

- Gear Transmission / Flap Transmission
- Call for Current Options
- Fuel Selector Valves
- PA30 - (Airborne 1H7 Series) repair base price \$450.00
- (New Strainer screen Market Price)
- New brass valve for Experimental
- Hoof valve repair available -Starting at \$300
- PA30 Heater regulator valve (exchange) \$CALL\$
- Weldon Boost Pumps (injected, PA30 ONLY) \$CALL\$
- Generator Exchange 50Amp Delco-Call for availability
- 70 AMP Stc'd Alternator Kit
- Single.....SAL12-70.....\$1885.00
- Twin.....TAL12-70.....\$3628.00
- New**
- Now Stocking PMA"D PA24-180/250/260
- Lower Cowl Scoops

All Prices Are Subject to Change Without Notice. Check with us for all your Comanche Needs.

Bearing/Bushing
21706-000
Upper & Lower
(Inner Trunion)
\$172.50 Ea.

Bushing 61402-012
180/250 Sn 1684-1748
\$35.00 Ea.
Bushing 14976-012
(All other Comanches)
\$25.75 Ea.

Bushing 14976-017
\$45.85 Ea.

Bushing 21831-002
\$65.00 Ea.

Bolt
260C ONLY 400-234 \$6.25
PA30/400 401-407 \$2.50
180/250/260 400-217 \$3.25

Nose Gear Misc.

Bushing
W20803-000
(180/250/260)
\$72.50 Ea.
W20803-002
(PA30/400)
\$94.35 Ea.

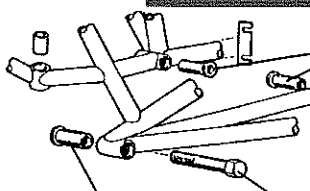

Bolt
402-530
\$CALLS

Bushing
17164-000 (180)
\$65.00 Ea.
17164-004 (Others)
\$123.98 Ea.

Bushing
PA24-180/250 Sn 1684-1748
61402-013 (3/4" OD) \$42.74 Ea.
61402-014 (1 1/16" OD) \$25.00
61402-015 (5/8" OD) \$30.53
(All other Comanches)
14976-013 (3/4" OD) \$25.75 Ea.
14976-021 (1 1/16" OD) \$61.76 Ea.
14976-023 (5/8" OD) \$75.80 Ea.
CA14976-102 (13/16" OD) \$49.50 Ea.
14175-113 (1" OD) \$105.00 Ea.
May of options on some.

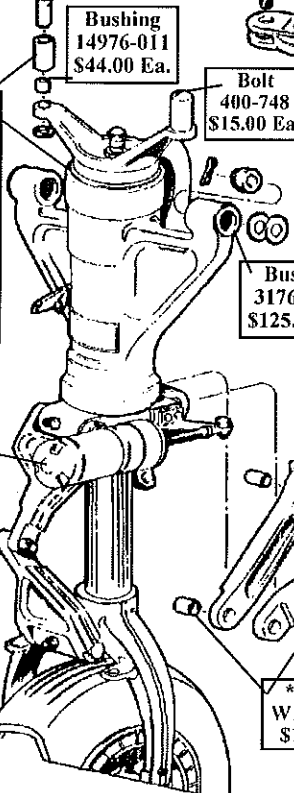

Bushing
14976-011
\$44.00 Ea.

Aligner 21725-000 CALL
Bushing 14976-015 \$34.00
Bushing 14976-016 \$69.85
Screw 411-349 \$15.50

Bolt 401-311
\$1.75 Ea.

Bolt
400-748
\$15.00 Ea.

Shimmy Dampner
STC'd - Rebuildable
PA24 Kit
PA30 Kit
CALL FOR OPTIONS

Kit - Nose Downlock Spring
761-082 - W/Spring
\$475 if available or
\$199.00 without spring.

Bushing
80012-006
\$25.00 Ea.

Spring
13098-000
\$Let's Talk\$

Bushing
31766-000
\$125.00 Ea.

* Bushing
W14843-018
\$18.00 Ea.

Bolt
LH (180/250/260) 400-219 \$4.00
LH (400/PA30/39) 400-223 \$4.00
RH (180/250/260) 400-216 \$4.00
RH (400/PA30/30) 400-218 \$4.00

Bolt
(not shown)
Nose gear retract rod
410-079
\$2.30 Ea.

Shims
21820-002 (0.016")
\$25.86 Ea.
21820-003 (.020")
\$17.50 Ea.
21820-004 (.032")
\$10.00 Ea.

Bolt
W22066-000
\$37.50 Ea.

* Bushing
W14843-018
\$18.00 Ea.

* Bushing
W14843-018
\$18.00 Ea.

Bolt
400-227
\$6.90 Ea.

* Drag Link Bushings
14843-018
\$18.00 Ea.
(7 total per nose gear)
W14843-019
\$22.55 Ea.
(1 total per nose gear)

Strut Seal Kits
(orings & wiper)
GK3 - 180/250/260
GK4 - PA30/400
\$15.50 Ea.

Washer
751-834
\$1.00 Ea.

Bushing 31766-000
\$125.00 Ea.

Placard
27257-00 Do Not Exceed
27258-00 Tow Turn Limits
\$7.15 Ea.

Strut Misc.

Valve Body
453-124
\$29.85 Ea.

Valve Core
455-124
\$3.30 Ea.

Bushing
Shimmy dampner attach
21487-000 PA24 1-214 \$25.00 Ea.
21831-003 PA24&PA30 \$68.50 Ea.

Bushing
Lower Gear Housing
Nose (2 per strut)
W20737-004 \$37.50 Ea.
Main (1 per strut)
180/250/260A&B
20737-003 - \$67.50 Ea.
260C/400/PA30
20737-016 - \$110.75 Ea.

** Bushing
20737-002
\$18.25

Bolt
402-313
\$3.50 Ea.

Bushing
452-366
\$3.86 Ea.
2 per gear
6 per A/C

Bolt - upper scissors
402-344 Nose \$8.10 Ea.
402-343 L Main \$24.50 Ea.
402-345 R Main \$15.15 Ea.

**
2 per scissors
half
4 per gear
12 per A/C

Bolt
402-344
\$8.10 Ea.
Used on all lower
scissors

Plug
20787-000
\$60.00 Ea.

Strut Tube
20789-000 180/250/260
PLUS CORE \$950.00
22785-000 PA30/400
PLUS CORE \$950.00
CALL FOR INFO/AVAIL.

** Bushing
20737-002
\$18.25



All Prices Are Subject to Change Without Notice

Main Gear Misc.

Link Rod
20768-000 LH 180/250
20768-001 RH 180/250
24911-000 (260 & 260B)
22577-000 (400/30 sn 2-694)
25046-000 (260C/PA30 695/UP)
P.O.R.

Rod End Bearing
W23412-000
180/250/260A&B
Call
W22943-000
(260C/400/PA30)
Call

Bolt
400-313
(180/250/260A&B)
\$9.65 Ea.
400-368
(260C/400/PA30)
\$9.90 Ea.

Spherical Bearing
452-367
Generic \$56.72 Ea.
(180/250/260A&B)
751-454
(260C/400/PA30)
\$124.68 Ea.

Bolt 400-016
\$1.50 Ea.
Bushings
14843-069 (Long)
\$55.00 Ea.
14843-079
(Short)
\$22.95 Ea.

Bungee Cord
31322-007
(8097)
(All Models)
\$29.50 Ea.

Spring
83302-040
\$48.00 Ea.

Bushing
20737-008
\$123.00 Ea.
per link assy
4 per A/C

Bolt
400-761
\$11.75 Ea.

Shims
14843-020
(.125" thick)
14843-093
(.062" thick)
19513-010
(.035" thick)
Call for Info

Bushing
W20737-006
(180/250)
W20737-014
(260/400/PA30)
\$40.00 Ea.

Bolt
401-346
(5 & 1/16")
\$14.50 Ea.
401-347
(5 & 3/16")
\$12.50 Ea.

Bungee Arm
Thick Wall
W20846-006 LH
W20846-007 RH
\$285.00 Ea.

Bushing
14843-060
\$75.95 Ea.
Bolt
400-757
\$11.50 Ea.

Bushing
W14843-030
\$24.25 Ea.

Bushing
W20737-005
(180/250)
W20737-013
(260/400/
PA30)
\$40.00 Ea.

Bushing
14175-050
\$26.50

PA24 Owners:
*Be aware that crack-
ing is common on the
thin wall bungee arms.*

Bushing
14843-016
\$14.75 Ea.
(4 per link assy)
(8 per A/C)

Stud
W20829-000 (180/250)
\$185.00 Ea. Piper \$405.00
W22512-000 260/400/30)
\$185.00 Ea. Piper \$308.50

Gear Door Misc.

Bracket
21320-006
Fore/Front
21322-006
Fore/Rear
Call for Info

Clevis
454-901
\$26.95 Ea.

Eye-Bolt
402-032
\$12.10 Ea.

Bracket
21320-007
Aft/Rear
21322-007
Aft/Front
Call for Info

Hinge
W21065-012
\$34.50 Ea.

Bracket
21068-00 LH/001 RH (180/250)
24842-00 LH/001 RH 260A/B)
24819-000 LH/001 RH
(260C/400/PA30 695 & UP)
22825-000 LH/001 RH (30 1-694)
Call for Info

Bushing
W80012-097
\$10.00 Ea. or
80012-006
\$25.00 Ea

Rod End
W452-383 \$18.50
CA452860A \$54.00
Call for Info

Bushing
14976-009
\$28.00 Ea.

Hinge
W21318-000
\$45.00 Ea.

Rod Assy
Complete
W21067-003
\$89.50 Ea.

Horn
21066-000
Call for Info

Rod Assy
Complete
21118-003
Call for Info

Spring Washer
408-833
\$10.60 Ea.

Gear Door
LH 22984-000
RH 22984-001
Call for Info

**260C & PA30
Nose Gear
Doors
Repair Parts
Available
Call for Info**



Bumper
Gear Door
453-887 Thin
\$7.25 Ea
453-646 Thick
\$3.00 Ea



All Prices Are Subject to Change Without Notice

AVAILABLE SOON!! ***
ALL NEW - FAA-PMA'd
Comanche Gear Push-Pull Conduits
P/N W455-180
Featuring:
All New Design
Stainless Steel Construction
Closed Seal System
Teflon Inner-Lined
No Lubrication Needed
Less Load on Transmission Assy
\$ TBA ***
Piper's \$1390.08 Ea.

Gear System Misc.

Spring
 Gear Trans. Emergency Release
 83302-039
 (PA24 SN 1-3557)
 Call for information
 83302-031
 (All Other Comanches)
 Call for information

Clevis Stud
 Nose Gear Drag Link
 20859-003
 (PA24-180/250)
 Call for availability
 23103-000
 (All Other Comanches)
 Call for availability

Nut
 Gear Conduit
 21063-000
 Only used available

DRESS UP YOUR INTERIOR!
PLATE
 Gear Lever
 Boot Attach
 W21207-000
 \$ 38.50

Carloc Stud
 Gear Access Door
 (Folding)
 487-668
 Call for Availability

Gear Lever Boot
 Replacement
 21280-000
 Call for options

Tube - Inner
 Nose Gear Trunion
 21707-000
 Call for Repair Options

Rod End Bearing
 Nose Gear Rod
 452-356
 (PA24 180/250 SN 1-3530)
 \$68.50 Ea. (NLA)
 Can use
 CA452-412
 (All Other Comanches)
 \$60.00 Ea.

Drag Links
 Nose Gear
 20814-000 LH Front
 20815-000 RH Front
 20819-000 RH Rear
 20817-000 LH Rear
 (180/250 SN 1-3225)
 23109-000 LH REAR
 (all other Comanches)
 Used/As Removed
 Call for Price & Availability

Rod End Bearing
 Gear Conduit
 452-377
 \$382.00 Ea.

Gear Transmission / Motor
 Repairs: call for options

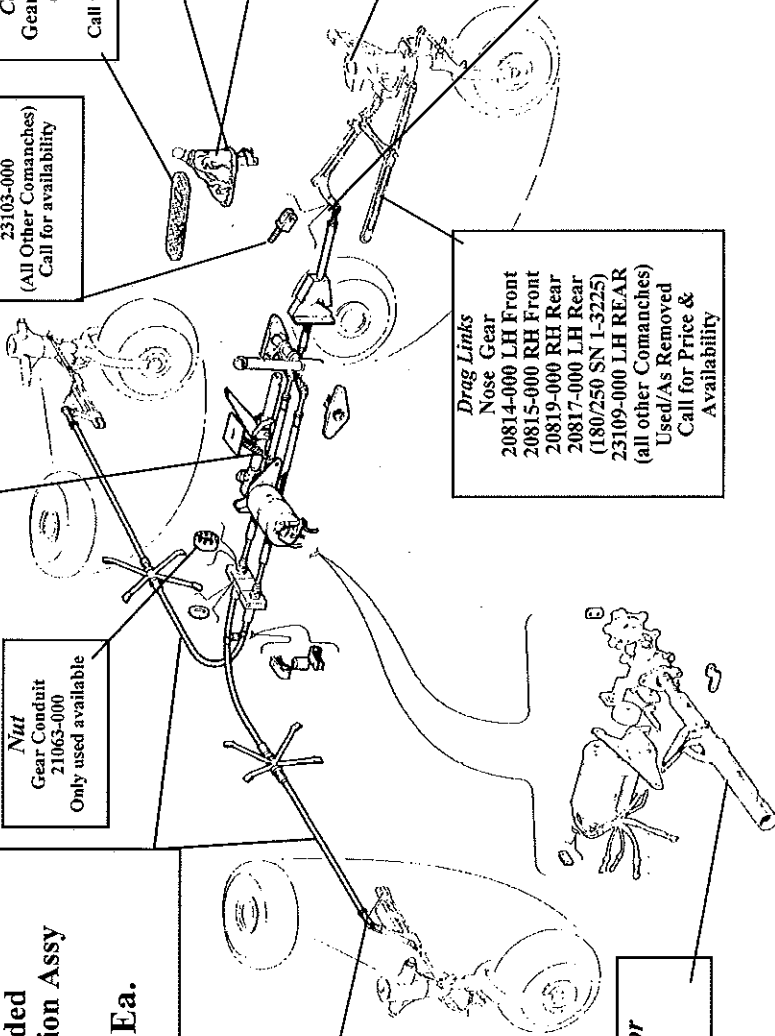

KEEP YOUR GEAR UP TO SPEED
 We stock all Comanche Gear Parts Including:
BUSHINGS / BOLTS
BEARINGS / ROD ENDS
LINKS / STUDS
CIRCUIT BREAKERS / SWITCHES
WIRING HARNESSES
SOLENOIDS / SPRINGS
GIVE US A CALL!

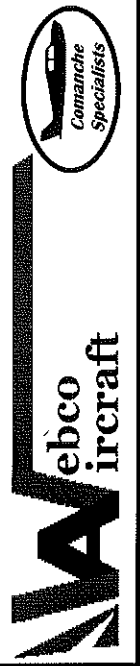

All Prices Are Subject to Change Without Notice

11/21/25 *Prices subject to change



1134 N. Oliver Road, Hgr G * Newton, Ks 67114 USA
Ph. 316-283-7929 Fax 316-283-4702 Email: Sales@webcoaircraft.com

SOON AVAILABLE!! ***
ALL NEW - FAA-PMA'd
Comanche Gear Push-Pull Conduits
W455-180

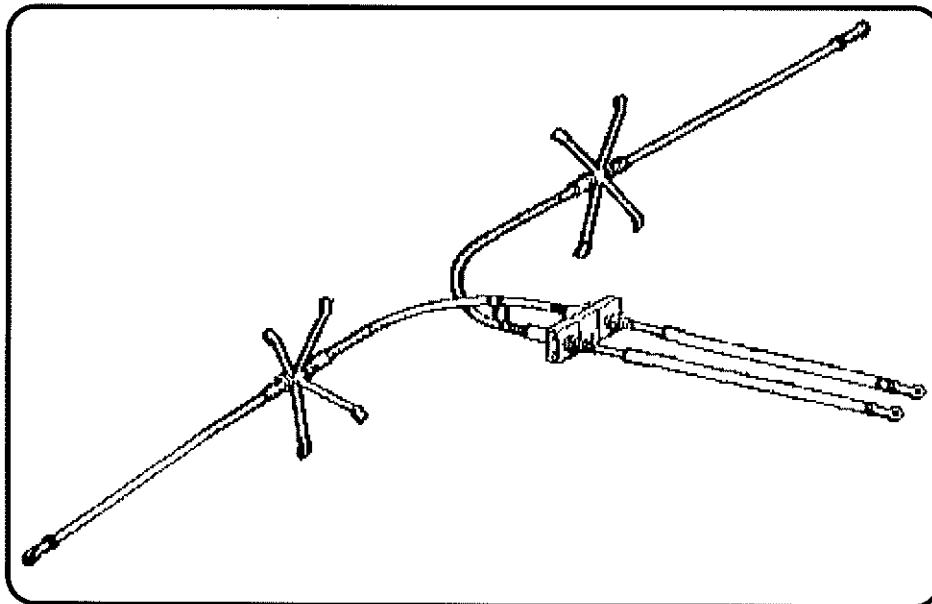

Featuring:
All New Design
Stainless Steel Construction
Closed Seal System
Teflon Inner-Lined
No Lubrication Needed
Less Load on Transmission Assy
TBA ***
Piper's \$1390.08 Ea

Tail Section Misc.

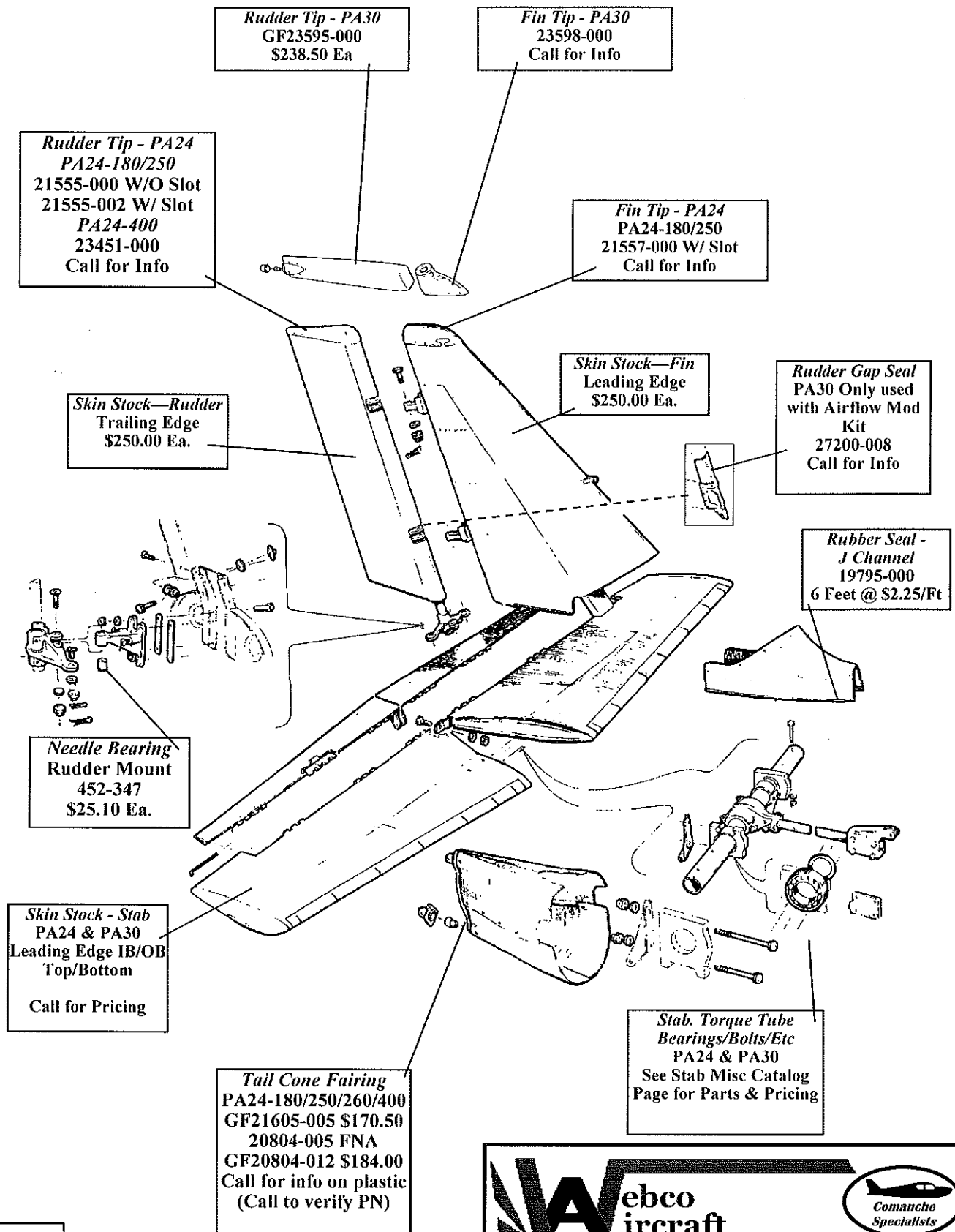

11/21/25

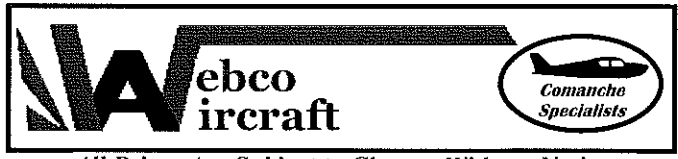

All Prices Are Subject to Change Without Notice

Stabilator Misc.

Bolt
 502-329 AN174C32A \$34.50 Ea.
 180/250/260 (4 per A/C)
 502-342 AN175C32A \$32.50 Ea.
 PA30/400

Bolt
 400-932 (AN24-46A) \$18.75 Ea.
 All Models (2 per A/C)

Bolt
 691-352 * (NAS6604-29) \$4.50 Ea.
 All Models (1 per A/C)
 * Replaces 402-321

Bolt
 502-343 (AN175C33A) \$32.50 Ea.
 All Models (2 per A/C)

Bearing
 W452-363 \$285.00 Ea.*
 All Models (2 per A/C)

Bolt - Lower
 401-380 AN5-54A \$19.85 Ea.
 180/250/260 (2 per A/C)
 401-382 AN5-56A \$18.85 Ea.
 PA30/400

Bolt - Upper
 401-383 AN5-62A \$ CALL \$
 180/250/260 (2 per A/C)
 401-384 AN5-63A \$25.00 Ea.
 PA30/400

Hinge Half (Tab side)
 20194-018 16914-000
 (180/250/260) (PA30/400)
 Call for Info

Hinge Half (Stab side)
 20193-028 (180/250/260/30)
 Call for Info 16194-000 (400)
 Call for Info

Hinge Pin
 21510-000 21510-002
 Call for Info (6 per A/C)

Stab Tip Block *
 20257-002 (Front, all but 400)
 20257-003 (Rear, all but 400)

Stab Screw *
 415-289 Rear 415-292 Front
 \$2.75 Ea.

Stab Tip
 180/250/260 Early PA30
 21556-000 Plastic Call
 21556-000F Fiberglass \$198.00
 Late PA30 / 39
 25066-000 Plastic Call
 25066-000F Fiberglass \$185.00

* Parts are different for PA24's with Stab Weight Mod kit installed.

11/21/25

Webco
ircraft



All Prices Are Subject to Change Without Notice

Stab Trim Misc.

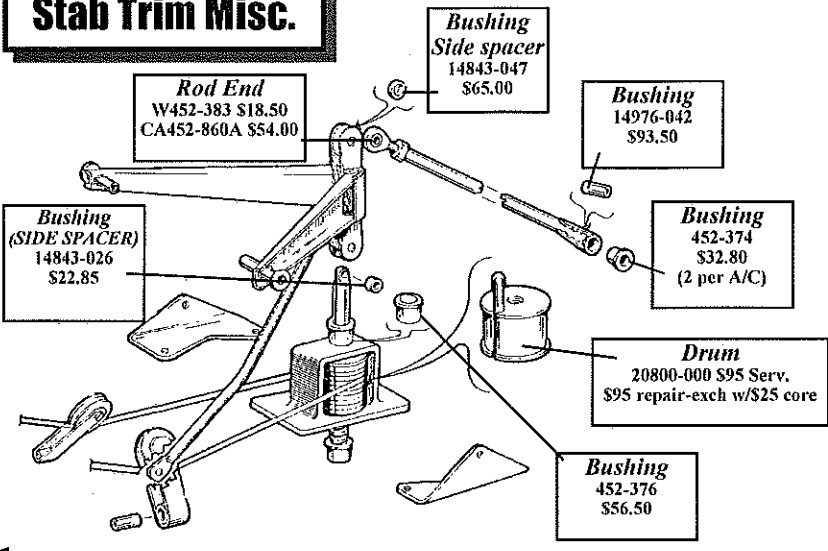

Rudder Pedal Misc.

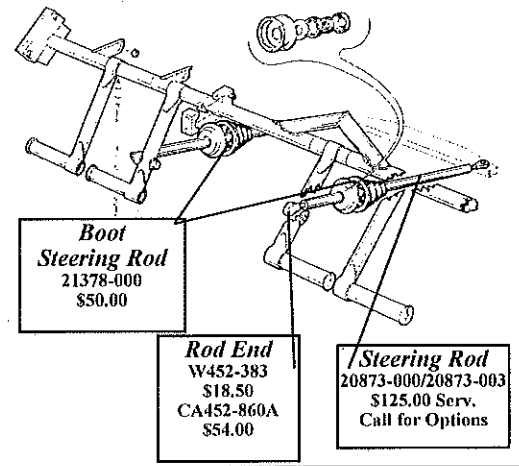

Elec. Flap Misc.

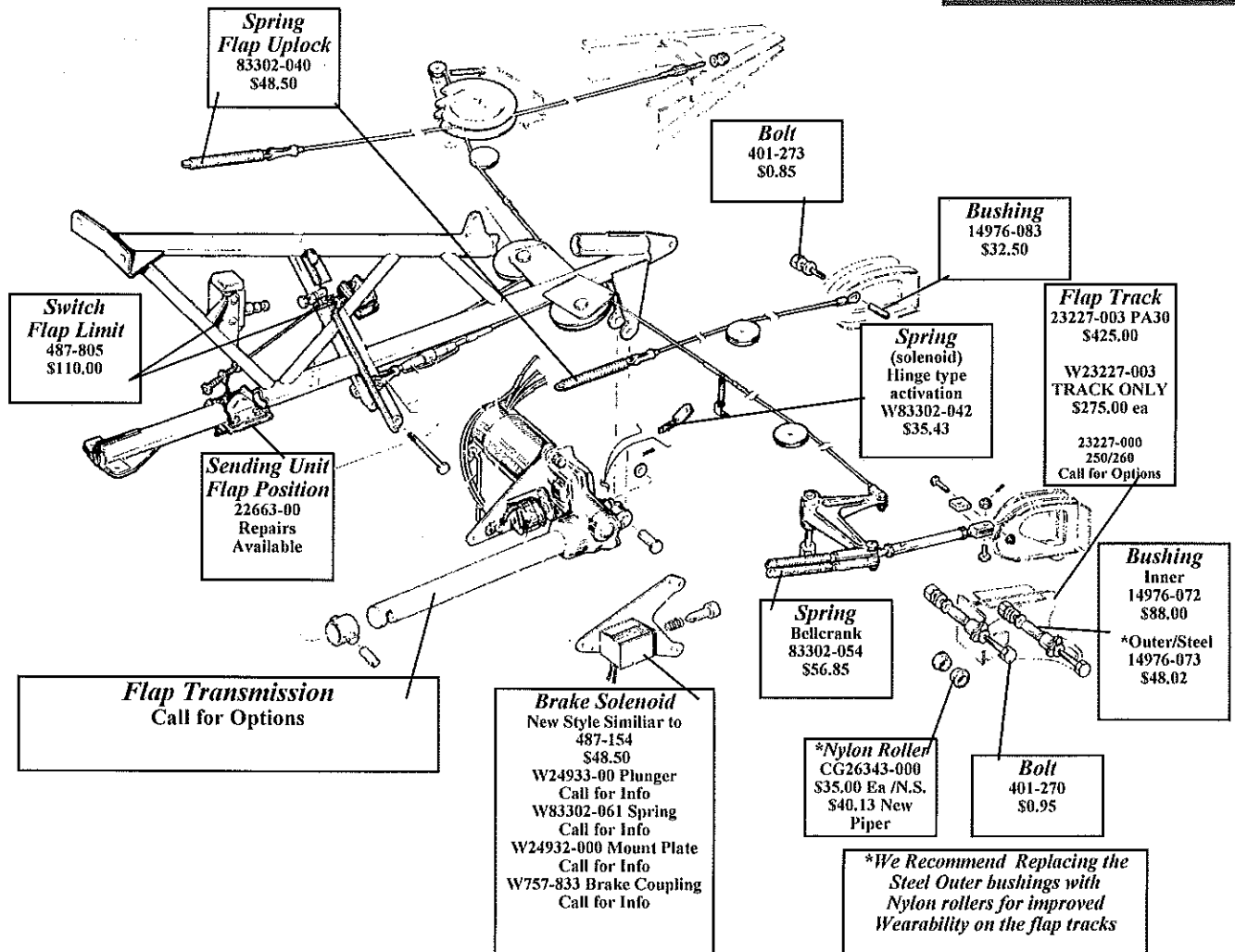

11/21/25



All Prices Are Subject to Change Without Notice

Fuel System Misc.

CamLoc Stud
 487-590 W/SS (2600-5SW) \$12.75
 487-692 W/SS (2600-8SW) \$12.50
 Stainless, Wing Head
 487-590 S/SS (2600-5S)
 Stainless, Slot Head
 \$11.85 Ea.
 494-060 Star Lock Washer
 \$0.68 Ea.

Fuel Door Gasket
 Call for Info
 20327-003
 PA24 Main/Aux / PA30 Main
 19051-000
 PA30 Aux / PA24-400 Aux
 Call for Info

Fuel Transmitters
 20966-000 All Main Tanks
 20966-002 All Aux Tanks
 Repairs Available

 751-884 Tip Tanks
 P.O.R.

 494-063 Sender Washer
 \$0.78 Ea.

 751-767 Sender Float
 \$14.00 Ea.
 462-021 Sender Gasket
 Call for Info

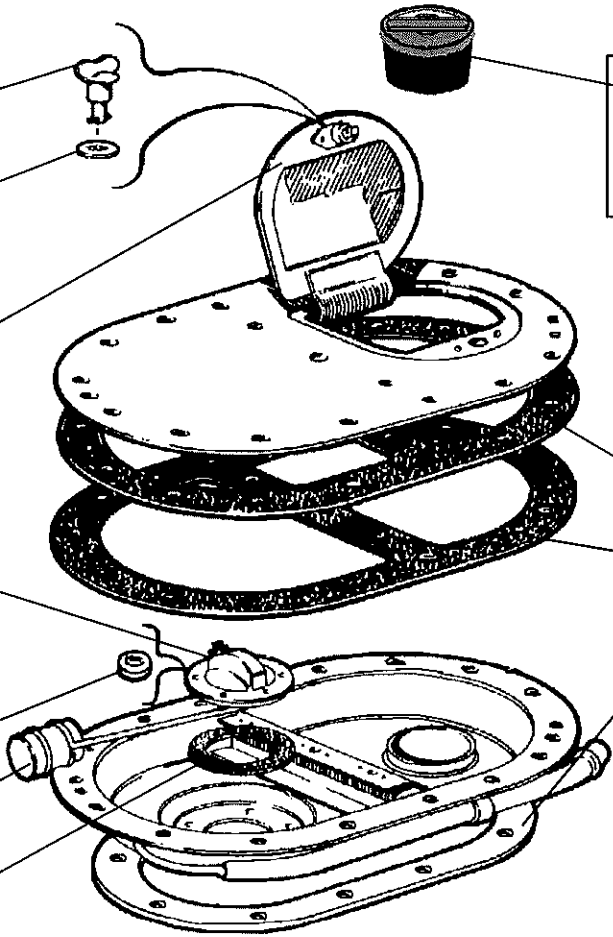

Webco PMA'd Fuel Caps
 \$60.00 Ea.
 (keep water out and fuel in)
 WFC1 - PA24 Main & Aux, PA30 Main
 PA30 Aux, PA24-400 Aux
 Piper Style (Flip handle) \$139.50

Fuel Door Lock
 DL5
 \$16.50 Ea.
 (similar to Cabin/Baggage door locks)
 Tubular style
 DL5T
 \$27.50 Ea.

Fuel Cell Gaskets
 20366-000 Upper, Thin
 20366-002 Lower, Thick
 462-014 Oval, Cork
 22846-000 PA30 Aux
 Call for Info

Gasket Set
 PA24 Main/Aux, PA30 Main
 (includes 5 gaskets)
 \$55.00 Per Tank

PA30 Aux
 (includes 6 gaskets)
 \$66.00 Per Tank

PA24-400 Aux
 (includes 12 gaskets)
 \$137.50 Per Tank

Fuel Strainer Assy
 PA24 SN 24-2299 & Up

 ← **Clamp Assy**
 22306-000
 P.O.R.

Snap Ring
 484-728
 \$8.00 Ea.

Fuel Strainer Screen
 W22458-000
 \$48.50

Fuel Sump Bowl
 W22034-000
 \$145.00

Drain Valve Assy
 22179-000 Type
 \$26.80

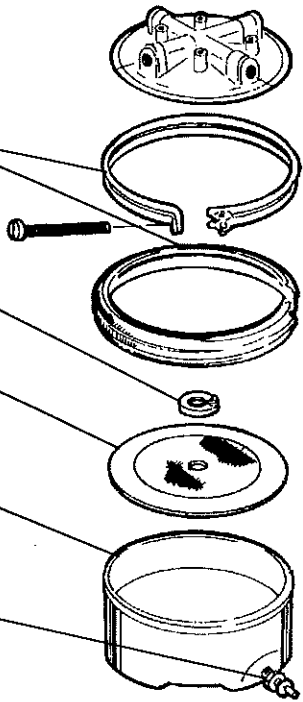

Fuel Strainer Assy
 PA24 SN 24-1 To 2298

Cover Assy
 14428-000
 \$130.00 Ea.
WHEN AVAILABLE
Fuel Strainer Screen
 750-272
 \$4.95 Ea.

Fuel Strainer Gasket
 85012-032
 \$4.95 Ea.

Drain Valve Assy
 CCA1550/492-022
 \$22.50 Ea.
 SEAL ONLY \$8.85

Wire Assy (Bail)
 494-644
 Call for Info



All Prices Are Subject to Change Without Notice

11/21/25

Intake & Exhaust Misc.

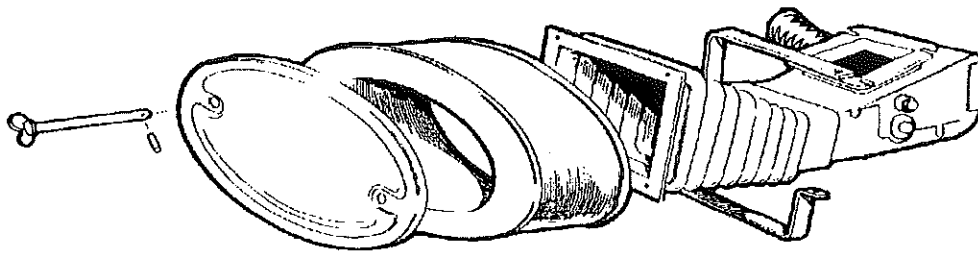

Stud 487-616 Call for Info	Pin 480-650 \$1.50	Air Filter Cover 16553-002 \$150.00	Air Filter Assy BA104 \$44.95 BA3 \$24.98	Coupling Boot W16559-000 \$325.00	Airbox Assy 21943-003 Call for Info
---	---------------------------------	--	---	--	--

Bushing & Shaft Repair Kit for ABOVE airbox – WAB3
 Butterfly flapper valve replacement for ABOVE airbox – WAB4
 (Brackett air filters and elements available for all other Comanches except 400)
 Bushing & Shaft repair kit for EARLY 250 airbox – WAB5
 Butterfly flapper valve replacement for EARLY 250 airbox – WAB6
 Bushing & Shaft repair kit for EARLY 180 airbox – WAB1
 Butterfly flapper valve replacement for EARLY 180 airbox – WAB2
 * Call for Information

**Muffler Shroud
(without plenum)**
 180 – SN 1 to 202
 W23503-000
 Call for Repair Options

180/250 SN 103-2298
 W23504-000
 Call for Repair Options

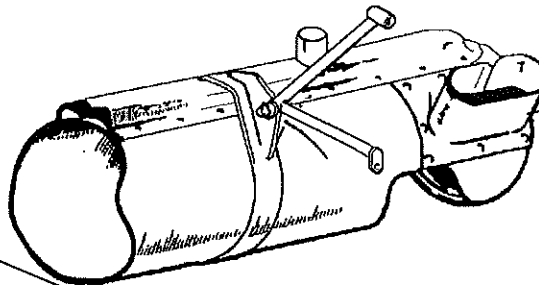

**Muffler Shroud
(with plenum)**
 SN's 2299 & Up
 180 – W23507-000
 Call for Repair Options

250 – W23489-000
 \$489.50

Muffler Clamp
 180/250 (2 9/16")
 W14235-008
 (some 180's use 2 1/16")
 W14235-000
 Call for Info

Shroud Clip
 W21247-000
 \$45.00

Tailpipe Clamp
 W21167-000
 Call for Info

Tailpipe
 180 – W21580-002
 Call for Info
 250 – W21580-000
 \$245.00

We also offer
 Exhaust gaskets.

Use measurement to identify
 Correct 250 carb shroud

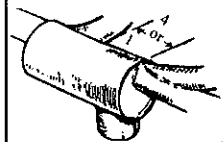

Carb Heat Shroud	
180 Lower – W21165-003 \$265.00	250 Lower – W24473-000 Call for Options
180 Upper – W21165-002 (SN 1-2298 w/90 deg takeoff)	250 Upper – W24472-002 (with 1 7/8" measurement)
180 Upper – W22093-000 (SN 2299/Up w/45 deg takeoff)	250 Upper – W24542-000 (with 4 1/4" measurement)
*Call for options	*Call for Options



09/11/25

All Prices Are Subject to Change Without Notice

Cabin Door Misc.

WDL1
Upper Door Latch Kit - \$765.00
 (8-12 Hours, Avg. Installation)

DS3
Cabin Door Seal
 Regular or Hollow
\$6.50 per foot
 11 FT REQUIRED
 MITRE LOWER CORNERS

1/4" Side Window Sets
Clear Bronze/Gray
 4 Place **\$1000.00 \$950.00***
 6 Place **\$1260.00 \$1200.00***
 (14-18 Hours Avg. installation time-Clean up
 Prep takes the longest)
 *Green Tint available at extra
 charge
 Set includes frameless vent in Pilots
 window.
 (frameless vent in Co-Pilot window
 available at extra cost)

464-022
Door Handle
\$90.00 / Piper
 Call for options

DK2
Reinforcement Brace
 (Lower door hinge area)
 \$82.50
Repair Part
 (2-4 hours avg. install time)

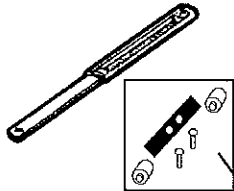

WDK1 - Holder Repair Kit
 (spring, rivets, rollers / repair your existing holder)
\$18.00
Webco Now Stocks the Door Steward
 Pneumatic Door Holder STC'd Kit at \$290.00

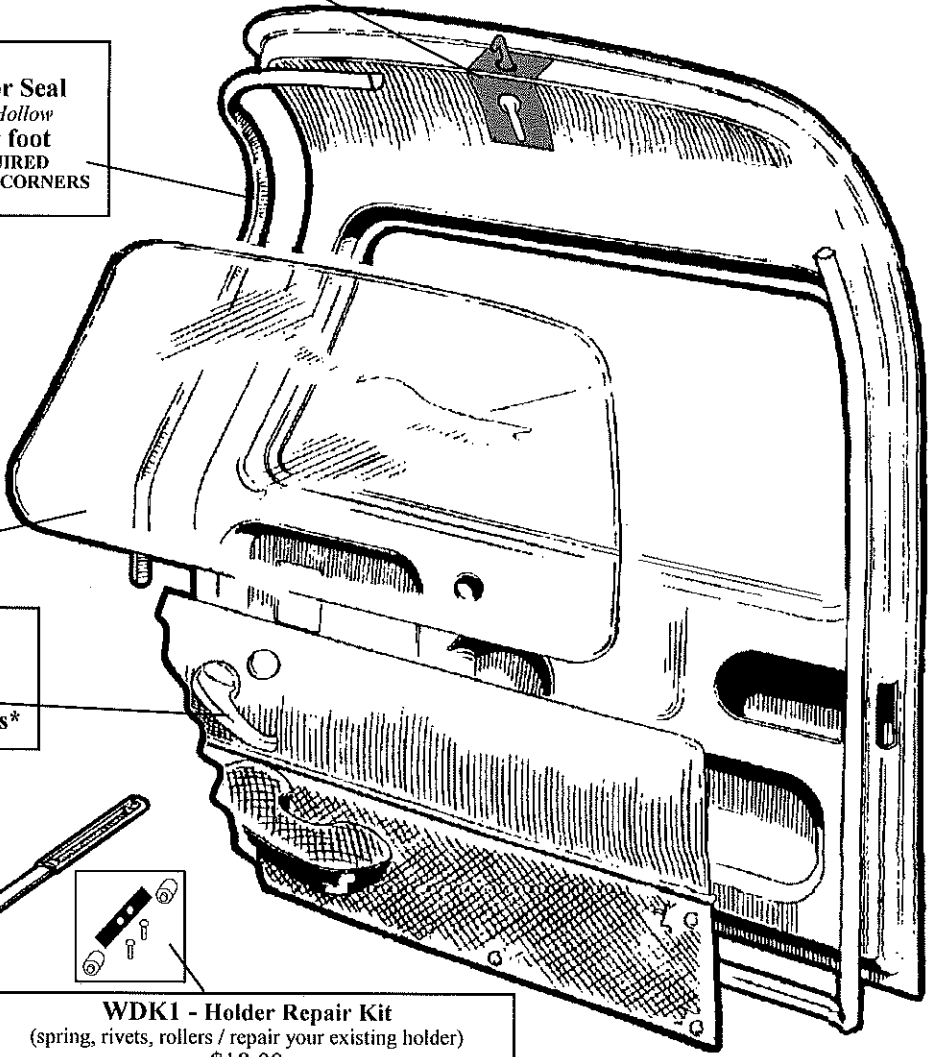

Baggage Door Misc.

Baggage Door Seal
 (PA24 w/Door on Co-Pilot Side)
 (same as cabin door seal)
\$6.50 per Foot
 (7 feet required)
 (PA24 Pilot Side Door)
 (PA30 All baggage Doors)
\$73.10 or \$46.50
per 10' Len
 (PN 23183-000)
 Inner cord (8ft) \$24.00

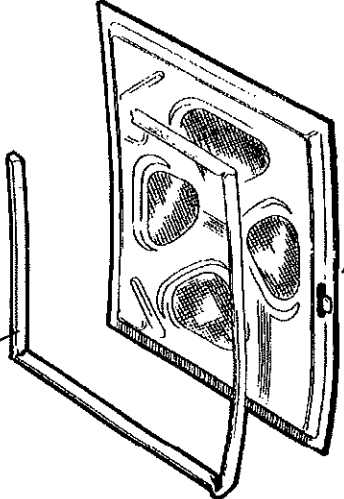

DL4 / DL5 Door Lock
\$16.50
DL5T
Tubular Door Lock
\$27.50
 (May be ordered keyed alike
 for use on both doors)



11/21/25

All Prices Are Subject to Change Without Notice



1134 N. Oliver Road, Hgr G * Newton, Ks 67114 USA
Ph. 316-283-7929 Fax 316-283-4702 Email: sales@webcoaircraft.com

Distributors of
Brand New
Comanche Fuel Cells

FAA-PMA Approved
Tested MULTI-PLY Construction
We have both Main & Aux
180/250 Early Main \$1295.00
250/260 Later 400 / PA30 Main \$1325.00
250/260 Aux \$1260.00
PA30 Aux \$1275.00
Call for options on 400 Aux

Fuel cell gasket set PA24 (includes all 5 gaskets needed)....\$55.00/Tank
*DISCOUNTED WITH FUEL CELL PURCHASE

Fuel cell gasket set PA30 (includes all 6 gaskets needed)....\$66.00/Tank
*DISCOUNTED WITH FUEL CELL PURCHASE

Fuel Door Gasket....20327-003....Call for Information

PA30 Aux 19051-000.....Call for Information

462-021 Fuel Sender Gasket.....Call for Information

751-871 Fuel Screen Gasket.....Call for Information

462-014 Large Oval Cork.....Call for Information

22846-000 Fuel Filler PA30 Aux...Call for Information

20366-000 Black Oval (upper).....Call for Information

20366-002 Black Oval (lower)... Call for Information

All Prices Are Subject to Change Without Notice. Check with us for all your Comanche Needs.

06/05/25



1134 N. Oliver Road, Hgr G * Newton, Ks 67114 USA
Ph. 316-283-7929 Fax 316-283-4702 Email: Sales@webcoaircraft.com

Gap Seal Kits

FAA-STC'D
BEST FIT
EASIEST INSTALLATION
BEST QUALITY
EXCLUSIVE BAKED-ON TEFLON COATING
ONLY \$680.00 Per Kit

NACELLE FUEL TANK KITS

Mounts in center
nacelle bay on
each side.

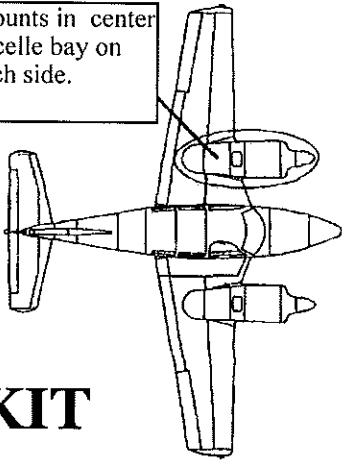

KIT

FAA-STC'D
FEATURES:
EASY INSTALLATION
10.2 GAL/SIDE, ALL USEABLE
ALL ENCLOSED PLUMBING
\$3500.00 COMPLETE

Side Window Sets

FAA-STC'D
BEST FIT
HIGHEST QUALITY
EASIEST INSTALLATION
BEST QUALITY
BEST VALUE AVAILABLE
PRICES START AT \$950.00 Per Set

All Prices Are Subject to Change Without Notice. Check with us for all your Comanche Needs.
01/07/25

ELECTRICAL COMPONENTS:

We stock most all Comanche Electrical Parts Including:

- Landing Light Bulbs
- Circuit Breakers
- Flap/Gear Switches
- Rheostats**
- Panel Switches
- Bulbs
- Cables
- Solenoids

GIVE US A CALL!

Upper Console

- 21309-00
- 24705-00
- 26637-004
- LENSES: 20635-002/003
- Call for Information SPEAKER: 21879-000 - \$50.00 Ea.

Electrical Misc.

Rotating Beacon

- Assy - WRML-14R
- SCALLS
- Lens - 754-527 \$40.80
- Bulb - 1940 \$13.60
- WRM1940 \$26.95

Pilot Tube

- Mast - 21299-000
- Call for Information Tube - 21301-000
- Market Price

Lift Detector

- 450-742
- Call \$725.20

Gear Warning Horn

- 565-375
- Call for Availability

Tail Nav Light

- Bulb
- GE93 - 180/250 \$3.00
- GE1073 - 260/400/30 \$3.50
- LENS - 751-203 \$42.85

Cable w/Bolt Positive

- 14069-000 \$83.70
- Air 66616-000 \$68.50

Clamp

- 454-925 \$28.00
- Tubing \$4.00/Fl.

Starter Solenoids

- 487-149 - 602-850
- All PA24/PA30 up to 1744
- Piper - \$128.50
- 487-163
- PA30 1745 & UP \$68.75

Gear/Flap Solenoids

- 487-152 - 584-420
- All Models \$165.00
- PMA'd Alternates \$115.00

Master Solenoid

- 455-342
- All PA24 \$365.50 Ea.
- 455-151
- PA30/39 \$350.00
- PMA'd Alternates \$115.00

Battery Cable Kits

- Mil Spec #2 Gauge Copper
- 180/250 solenoid top pilot \$210.00
- 180/250/260 solenoid bottom co-pilot \$210.00
- 260B - \$155.50
- 260C - \$192.50
- PA30 (Front/Rear Battery) 250.00

Gear Switch

- 487-820
- SAFETY/SQUAT - 180/250/400 PA30 up to 694
- L&R DOWNLOCK - 180/250/400 PA30 up to 694 \$185.00 Ea.
- 487-864
- L&R DOWNLOCK/SAFETY/SQUAT - 260 ALL
- RH DOWNLOCK ONLY - PA30 695 & UP \$725.50 Ea.
- 487-863
- LH DOWNLOCK/SAFETY/SQUAT - PA30 695/UP \$795.80 Ea.

Ignition Switch

- 14314-002
- 180 1-2298/250 1-2201 \$525.50 Ea.
- 756-115
- All Other PA24 \$648.50 Ea.
- Alternate \$115.00*
- Call for details

Guard

- 17807-000
- Call for Information
- Boot 10P AI \$28.50 Ea.
- Boot Assy 1P AI5 \$30.00

Bracket/Actuator

- MCD271H \$115.50 Ea. SERV.

Nose Gear Switch

- 487-820
- NOSE GEAR DOWNLOCK
- 180/250/400 PA30 up to 694 \$185.00 Ea.
- 487-862
- NOSE GEAR DOWNLOCK
- ALL 260 - PA30 695 & UP \$525.00 Ea.

01/26/26

W **airbeco**
ircraft



All Prices Are Subject to Change Without Notice

Nacelle Tanks

FEATURING:

Easy Installation, approximately 35-40 hours.
Economically priced at \$3500.00 for Complete kit & STC.
10.2 gallons per side, all useable.
All enclosed, no external plumbing except vent,
drain & overflow tubing ends.

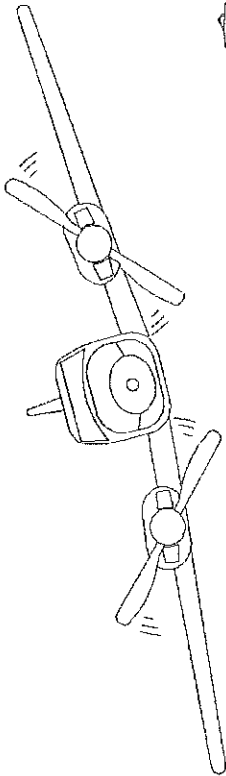

Mounts in center nacelle bay on each side.

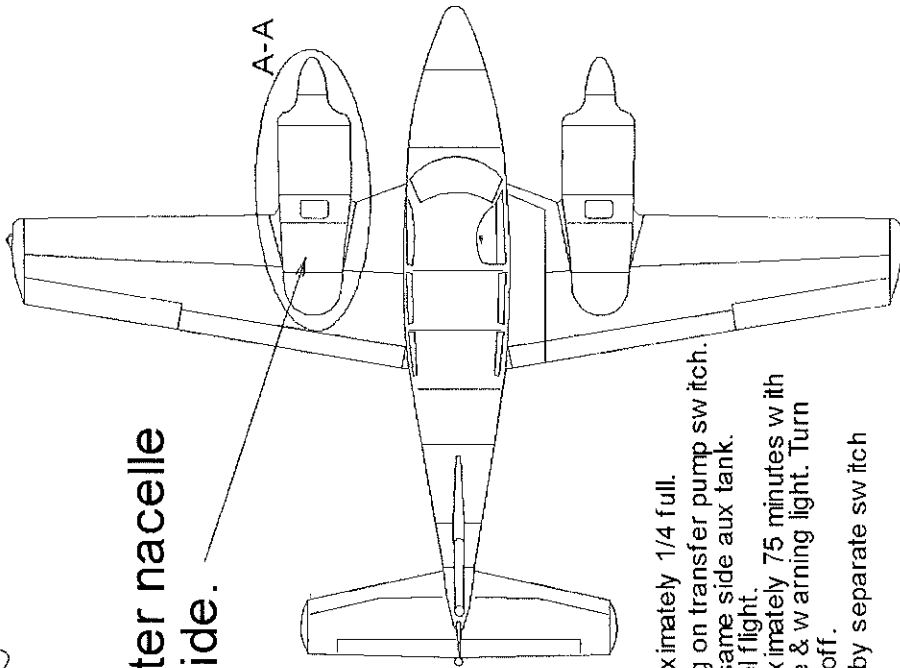

VIEW A-A

LH side shown with center nacelle skin removed.

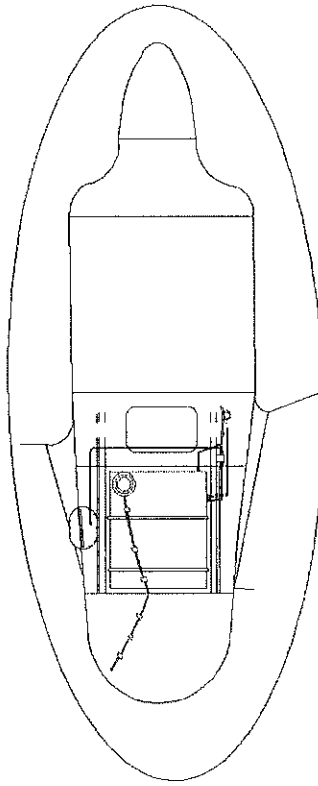

Operation Procedure:

1. Burn aux tanks to approximately 1/4 full.
2. Begin transfer by turning on transfer pump switch. Fuel is transferred into same side aux tank.
3. Transfer must be in level flight. Transfer will take approximately 75 minutes with completion noted by time & warning light. Turn nacelle transfer switch off.

Note: Each side controlled by separate switch and lights.

FULLY STC'D & PMA'D!
YOUR MECHANIC CAN INSTALL.

APPLICATION:
Piper PA30/39, All SN.

Webco
ircraft



All Prices Are Subject to Change Without Notice

01/09/25

PA30 Engine Misc.

Air Filter

NON-TURBO
460-650 Orig.
\$Aval? PMA \$68.50
BA105 Assy \$45.85 Ea.
BA10 Element \$36.00 Ea.

TURBO
201485 Orig.
\$198.50 Ea
BA121 Assy \$50.95 Ea
BA27 Element \$25.50 Ea

NOW AVAILABLE

Alternate Air Box
23810-000 Assy \$850.00 Max. Repair (\$75.00 Core Charge)

Components
23809-010 Door Assy Call for Availability
Hinge/Spring Call for Availability
23809-004 Door Seal Call for Availability
23995-000 Bellcrank/Cam Call for Availability
W25246-000 Bracket \$45.00 Ea.

Oil Cooler Replacement
18622-000 \$564.00 Ea.

Hanger/Strap Attach Clamp
W25973-000 \$43.50 Ea.
80002-076 Call for Availability

Baffle Tie Rod
10487-006 Call for Availability

Breather Tube
23845-000 Call

Non-Turbo Air Filter Box
23883-000 Call for Information

Air Filter Box Lid
23886-000 Call for Information

Repairs Offered

Tach Reverser
451-900 \$240.00 Ea.
(C/R Engines only)

Oil Cooler Hose Set
W-OC4 Call for Pricing

Exhaust Stack
23850-008 RH Front
23850-010 LH Front
23850-011 RH Rear
23850-012 LH Rear
P.O.R.
(+ \$100.00 Core Charge on each)

Pre-Cut Baffle Rubber
WBF30NT Non Turbo - \$49.50
WBAF30TB Turbo - \$63.25

We now carry the metal baffle parts from Airforms

Spinner Composite
Lifetime Warranty
23818-000 Comp Call
23818-000 Piper Original Aluminum \$1900.00/Call
23819-000 DOME \$65.00

Spinner Bulkhead
W23815-000 \$324.50 Ea.
W26313-000 (Heavy Duty & 260C) \$378.50 Ea.

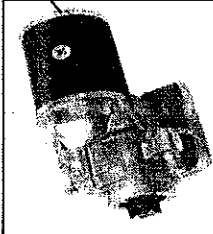

B&C Lightweight Starter
10.2 Lbs
Best Quality Available
No Bendix Problems
\$1035.00
C/R also available



Wabco Aircraft

All Prices Are Subject to Change Without Notice

11/21/25
*Prices Subject to Change

PA30 Turbo Misc.

**Turbo Inlet Scoop
RJ0617-3
Call for Info**

**Duct Hose
RJ9502-20-22-6A
\$70.40 Ea.**

**Grommet
RG56W
\$3.00**

**Duct Hose
RJ9503-18-19
\$60.00**

**Duct Hose
RJ0632
\$156.85**

**Gasket
RJ0115
\$30.80**

**Turbo Air Filter
201485 Original
\$198.50 Ea.
Brackett Brand
BA121 Assy - \$50.95
BA27 Element - \$25.50**

**Clamp
RJ0193
\$400.00**

**Duct Hose
RJ9504-28-15
\$155.00**

**Gasket
RJ0114
\$30.80**

11/21/25



All Prices Are Subject to Change Without Notice

Interior Misc.

PA24 - Later

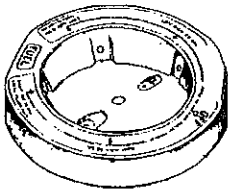

Dish w/o decal - 37.75
Decal - \$14.50

PA30 - w/o Tips

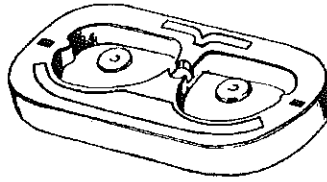

Dish w/o decal - \$35.75
Decal - \$15.00

PA24 - Early

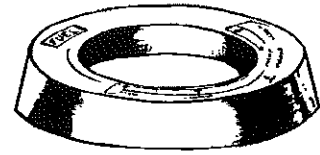

Dish w/o decal - \$35.75
Decal - \$13.75



24741 Plate - \$16.50
21154 Scoop - \$16.50

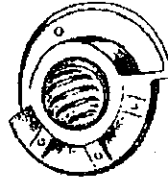

26441 Plate - \$17.50
25593 Louver - \$16.50



24741 Plate - \$16.50
24738 Scoop - \$16.50

Wing Tip Misc.

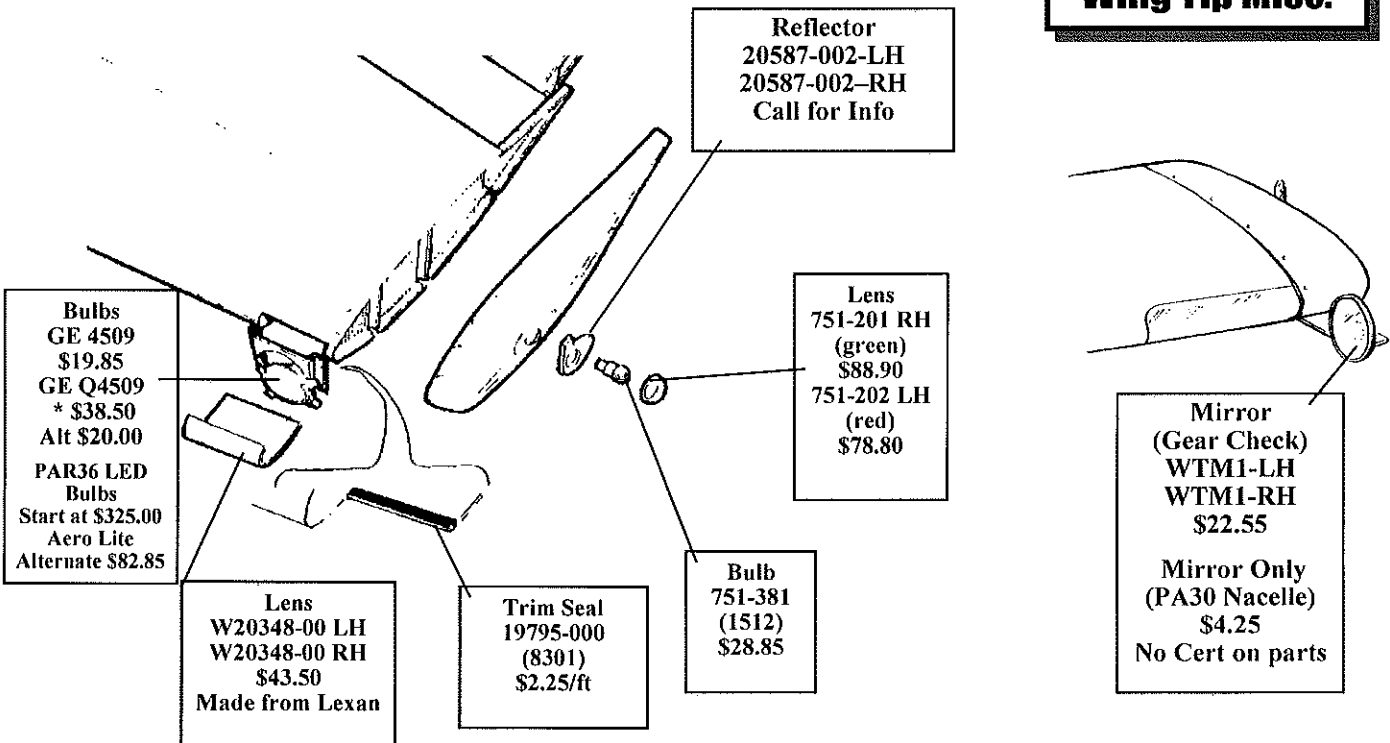

A Good Value

* The "Q" 4509 bulbs are the best deal. Compare specs:
4509 - 100 watts, 25 hours, 110,000 Candlepower
Q4509 - 100 watts, 100 hours, 140,000 Candlepower
(Brighter, Lasts 3x longer, uses same amount of watts)

11/21/25



All Prices Are Subject to Change Without Notice

Now Stocking: Bogert Battery Boxes, Tow Bars and Bungee Cord Installation Tools

Bogi-Bar Vehicle Tow-Bars
\$225.00 Ea

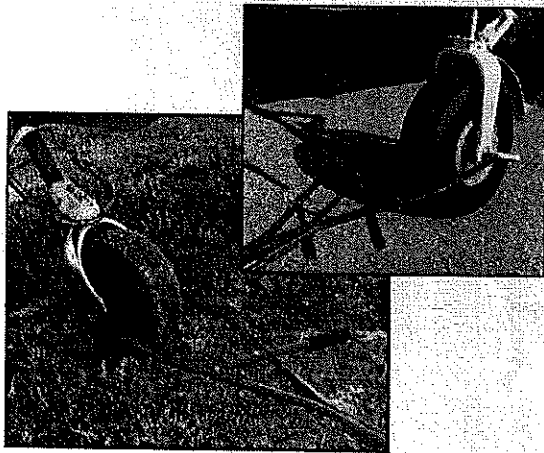

**STC'd Replacement
Battery Boxes**

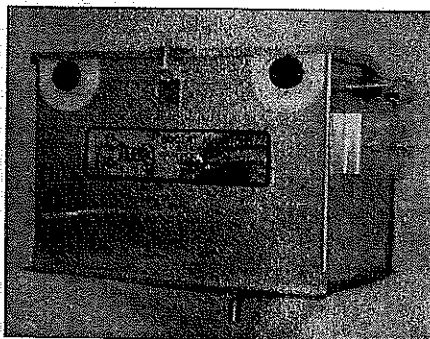

Replaces Both
Plastic & Metal
Piper Boxes
STC'd
For many Models

Bungee Cord Install Tool
\$217.00 Ea

**Bungee Cord Tool
Parts Description**

- A Pivoting Shoulder
- B Safety Slide Lock
- C Elbow
- D Thumb Post
- E Installation Tool

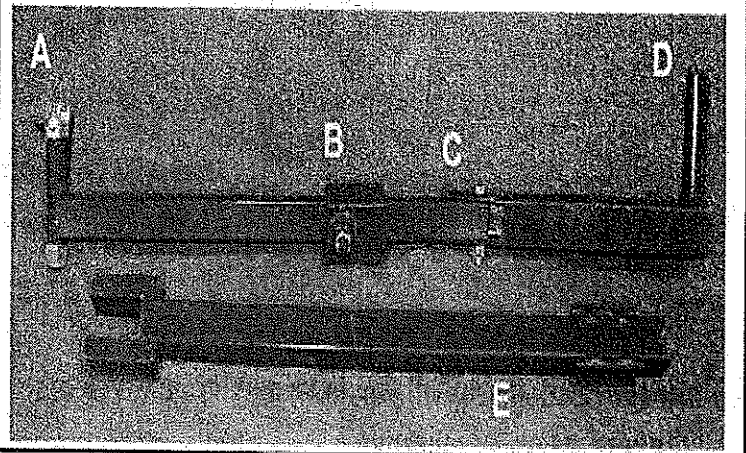

**Call for Current
Pricing &
Availability**



1134 N. Oliver Road, Hangar G * Newton, Ks 67114 USA
 Ph. 316-283-7929 Fax 316-283-4702 Email: sales@webcoaircraft.com

STC'd Alternator Conversion Kits For Single and Twin Engines

Single Engine \$1875.00

SKU# SAL12-70

Description: 12/14 volt, 70 amp*, replaces generators
 On many Piper and Mooney aircraft with Lycoming
 Engines.

Warranty: 2-Year Limited

Alternator Weight: 10 Pounds

Price: \$749.00

*Aircraft electrical system will be limited by existing wiring and
 Output breaker. The Plane-Power alternator can produce all 70
 amps if proper size wiring and circuit breaker is installed.

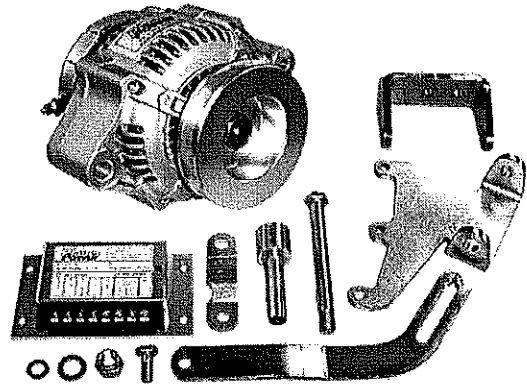

Twin Engine \$3628.00

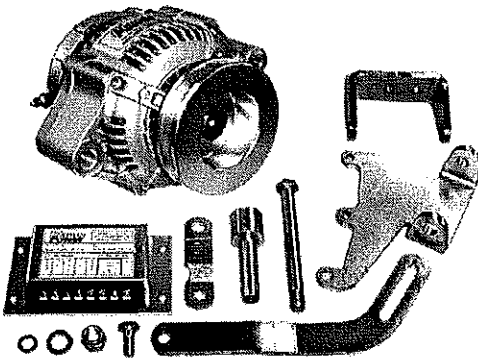

SKU# TAL12-70

Description: 12/14 volt, 70 amp*
 Alternator kit, replaces generators on
 many twin-engine Piper aircraft with
 Lycoming engines.

Warranty: 2-Year Limited

Alternator Weight: 10 Pounds

Price: \$1499.00

*Aircraft electrical system will be lim-
 ited by existing wiring and output
 Breaker. The Plane-Power alternator can
 produce all 70 amps if proper size
 Wiring and circuit breaker is installed.

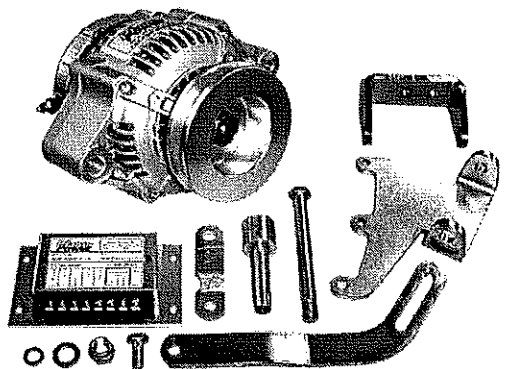

Prices subject to Change Without Notice

03/07/25

Webco aircraft



1134 N. Oliver Road, Hgr G * Newton, Ks 67114 USA

*Check out the Door Steward,
an STC'd affordable replacement for your door holding woes.*

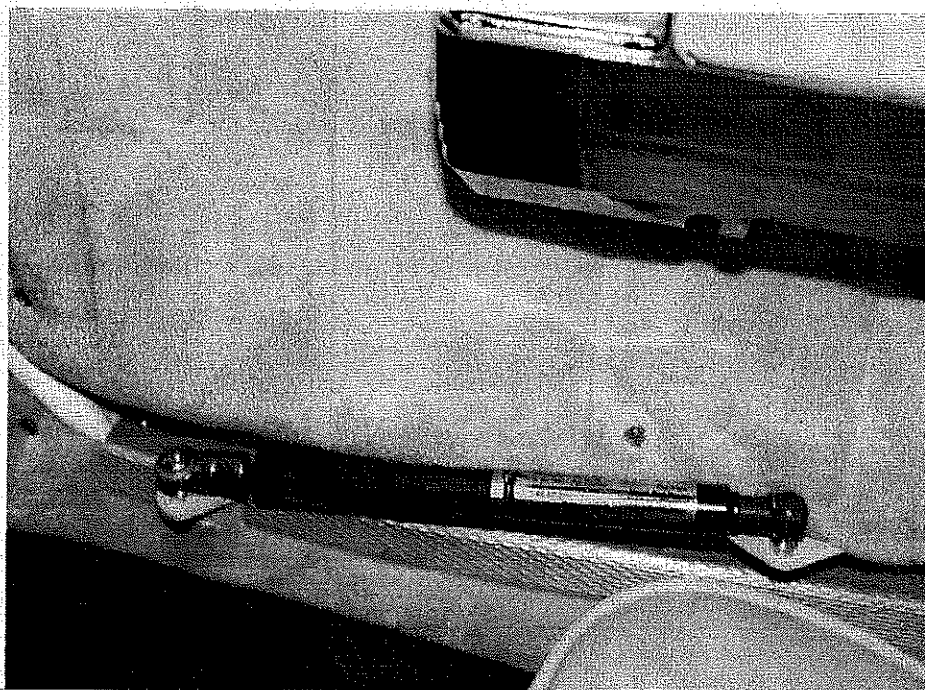
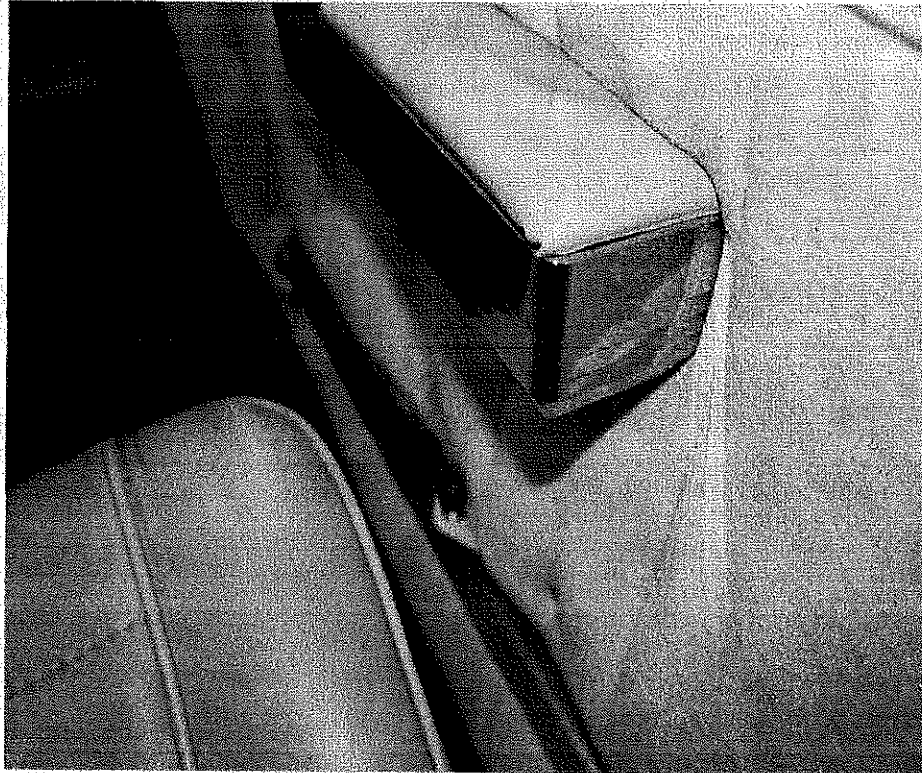

Only \$276.00 complete.

** All Prices Subject to Change Without Notice.*

Now
Selling

PIPER "GOLD"

FIT ALL PIPER AIRCRAFT MODELS & TYPES
GOLD TINI SPUTTERED OR SATIN BUFFED
STAINLESS STEEL ANGLED RINGS & SKID
SAFE TO 230+ MPH FRONT OR SIDE GROUND WIND
OVER 1000 SETS SOLD!

Rings and Skid Fit All PIPER Aircraft Types-



GOLD TINI SPUTTERED ANGLED RINGS \$236/EA



GOLD TINI SPUTTERED SKID & STRIKEPLATE \$236/EA

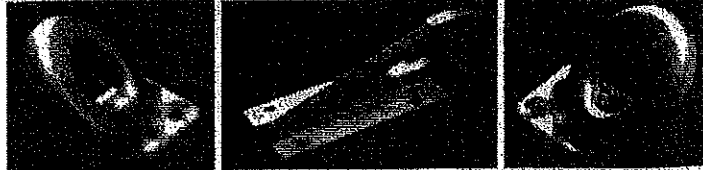

SATIN STAINLESS STEEL RINGS & SKID \$198/EA
Also, Ni Plated or White Rings & Skid \$198/EA
FREE SHIPPING & SCREWS +(Great Fuel Ground)





1134 N. Oliver Road, Hgr G * Newton, Ks 67114 USA

NOW AVAILABLE!!!

From Matt Kurke at Comanche Gear two of his publications. Landing Gear Push/Pull Cables Manual and 1000 Hour Gear Inspection Manual.

Comanche

**Landing Gear
Push/Pull Cables
Installation and
Adjustments Manual**

Copyright © 2024
Webco Aircraft, LLC - All Rights Reserved

Made with pride by:

**Comanche
Gear**

Parts and Other Stuff for

Matt Kurke, A&P, ICS, BSME PHON

Comanche

1000-hour gear inspection:

**Taking the Mystery out of
AD 77.13.21, Part A
for Singles and Twins**

Copyright © 2024
Webco Aircraft, LLC - All Rights Reserved

Made with pride by:

**Comanche
Gear**

Parts and Other Stuff for your Comanche

Matt Kurke, A&P, ICS, BSME PHONE 316-283-7929
webcoaircraft .com

Landing Gear Push/Pull Handbook — \$30.00

1000 Hour Handbook— \$65.00

* All Prices Subject to Change Without Notice.